

SAMSUNG

OWNER'S INSTRUCTIONS & INSTALLATION MANUAL

AP500PF

FLOOR STANDING TYPE AIR CONDITIONER
(Cool)

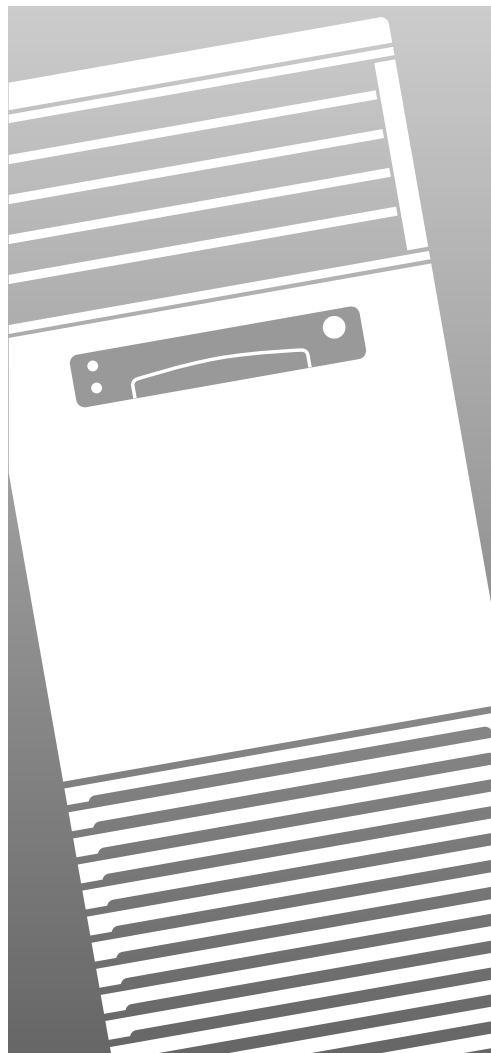

Safety Precautions

The following safety precautions must be taken when using your air conditioner.

- 1 Make sure that the indoor unit is correctly ventilated at all times; do NOT place clothing or other materials over it.*

 - 2 NEVER spill liquids of any kind into the indoor unit. Should this happen, turn the power switch off and contact your installation specialist.*

 - 3 Do NOT insert anything between the air outlet blades as the inner fan may be damaged and you may be hurt. Particularly, keep children away from the indoor unit.*

 - 4 Do NOT overload wall sockets or extension cables.*

 - 5 If the remote control will not be used for a long time, remove the batteries, and keep in remote control case.*

 - 6 Users of this product are cautioned not to attempt repair of this product at their own discretion. Instead, they are requested to directly contact a designated service center or the outlet at which the product was purchased.*

 - 7 If the supply cord is damaged, it must be replaced by a special cord or assembly available from the manufacturer or its service agent.*
-

Contents

◆ PREPARING YOUR AIR CONDITIONER	
■ Safety Precautions	2
■ View of the Indoor Unit & Outdoor Unit	4
■ Remote Control - Buttons	5
■ Control Panel	5
■ Getting Started	6
■ Inserting the Remote Control Batteries	7
■ Setting the Time	8
◆ OPERATING YOUR AIR CONDITIONER	
■ Operating Preparation	9
■ Using the Control Panel on the Indoor Unit	9
■ Using the Remote Control	9
■ Selecting the Automatic Operating Mode	10
■ Cooling Your Room	11
■ Changing the Room Temperature Quickly	12
■ Airing Your Room	13
■ Adjusting the Air Flow Direction Horizontally	14
■ Adjusting the Air Flow Direction Vertically	14
◆ PROGRAMMING YOUR AIR CONDITIONER	
■ Setting the Off Timer	15
■ Cancelling the Off Timer	15
◆ RECOMMENDATIONS FOR USE	
■ Operating Recommendation	16
■ Temperature and Humidity Range	16
■ Cleaning Your Air Conditioner	17
■ Solving Common Problems	18
■ Technical Specification	19

View of the Indoor unit and Outdoor unit

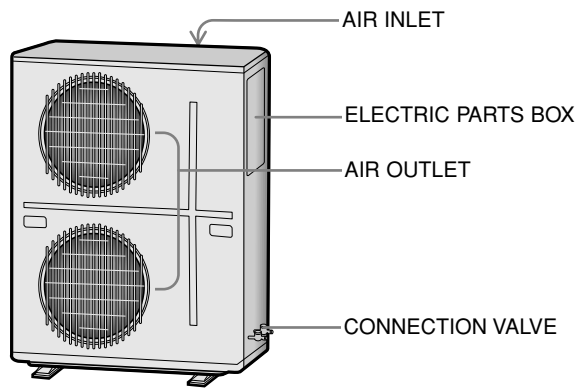
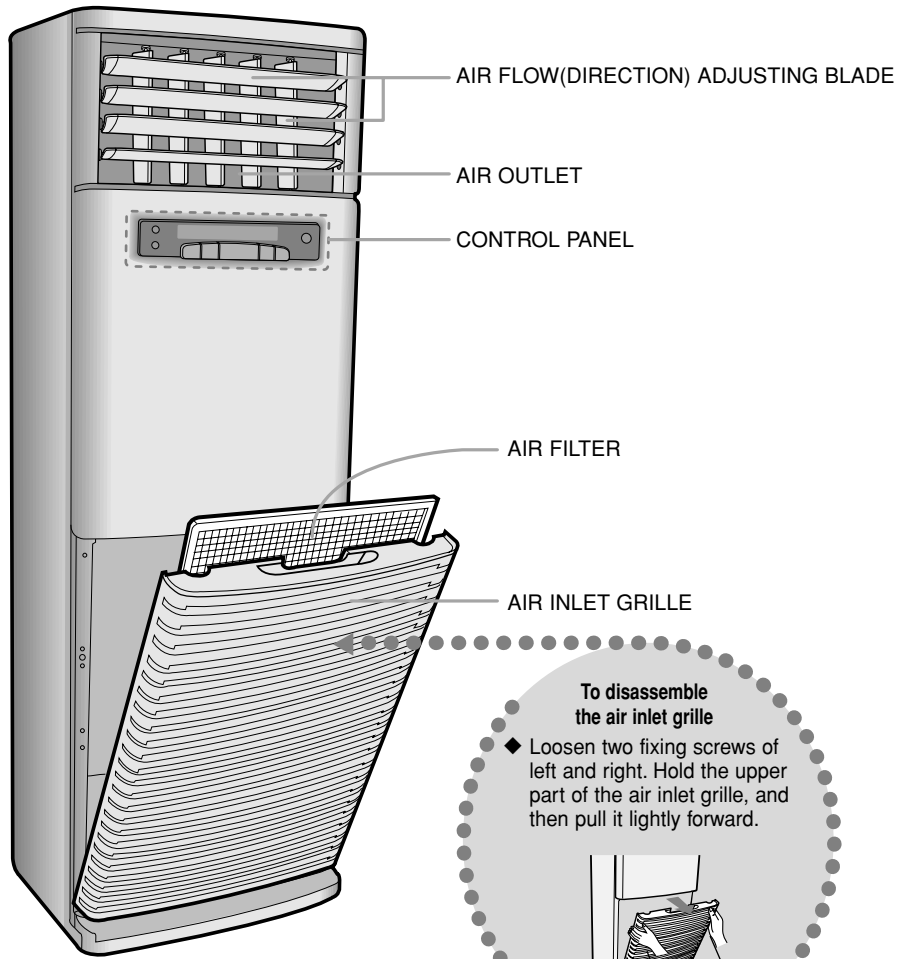

Remote Control - Buttons

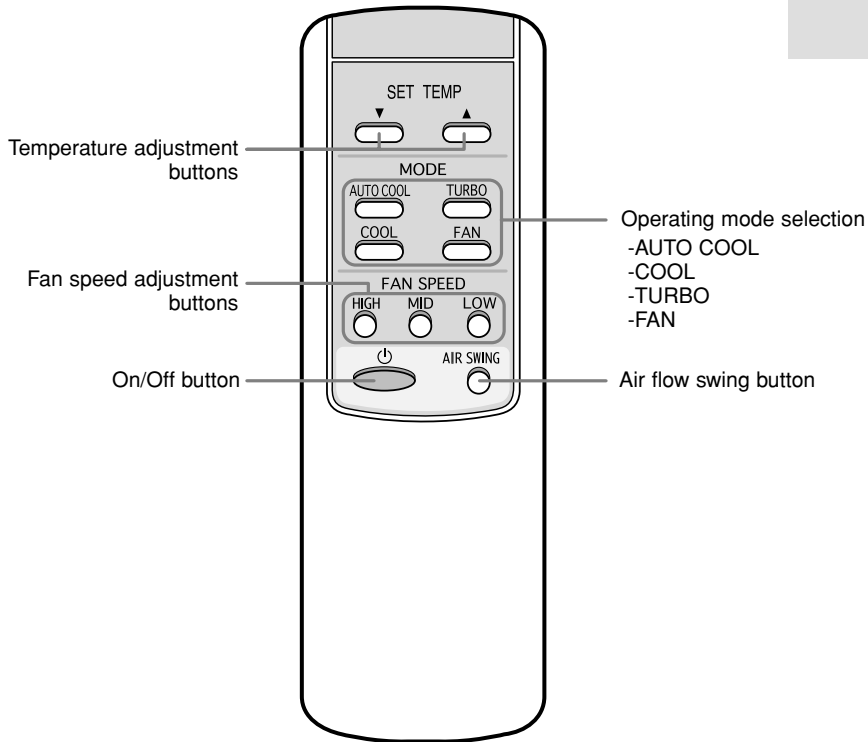

Control Panel

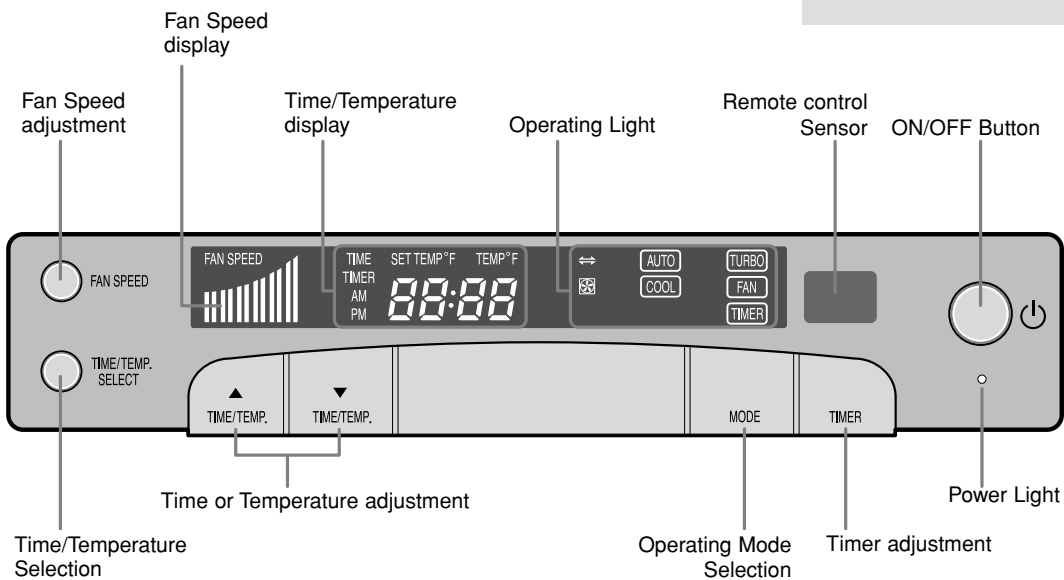

Getting Started

You have just purchased a packaged air conditioner and it has been installed by your installation specialist.

Your Owner's Instructions contain much valuable information on using your air conditioner. Please take the time to read them as they will help you take full advantage of the unit's features.

The booklet is organized as follows:

- ◆ *The following figures are shown on page 4 and page 5*
 - *Remote control (buttons)*
 - *Indoor unit*
 - *Outdoor unit*

They will help you find the buttons and understand the symbols displayed.

- ◆ *In the main part of the document, you will find a series of step-by-step procedures for each function available.*

The illustrations in the step-by-step procedures use three different symbols:

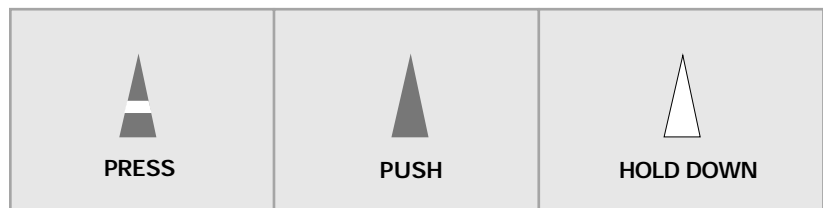

Inserting the Remote Control Batteries

You must insert or replace the remote control batteries when:

- ◆ You purchase the air conditioner
- ◆ The remote control does not work correctly

Note Use two LR03(AAA) 1.5V batteries. Do not use old batteries, or different kinds of batteries together. Batteries may be completely discharged after 12 months, even if they have not actually been used.

1 Push the battery cover on the rear of the remote control with your thumb in the direction of the arrow and remove it.

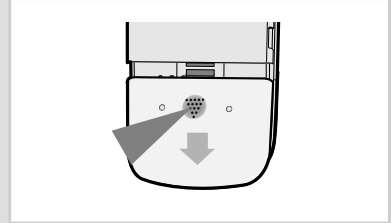

2 Insert the two batteries, taking care to respect the polarities:

- ◆ + on the battery with + on the remote control
- ◆ - on the battery with - on the remote control

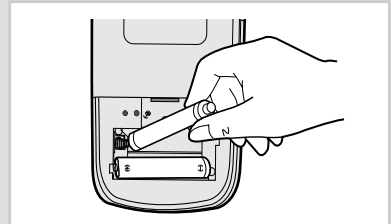

3 Close the cover by sliding it back until it clicks into place.

Setting the Time

You can set the time when you purchase the air conditioner.

Nota Be sure to reset the time when you change clocks from standard daylight saving time and vice versa.

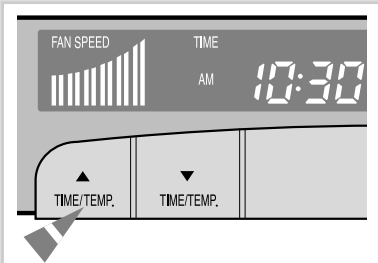
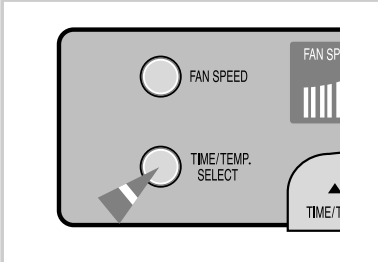

- 1 Press the TIME/TEMP. SELECT button.

Result: The TIME indicator flashes.

- 2 To set the current time, press the TIME/TEMP. ▲ or ▼ buttons.

To ...

- Increase the time in one-minute intervals
- Increase the time in ten-minute intervals
- Decrease the time in one-minute intervals
- Decrease the time in ten-minute intervals

then ...

- Press the (▲) button.
- Hold down the (▲) button.
- Press the (▼) button.
- Hold down the (▼) button.

Result:

- ◆ AM or PM are displayed to indicate whether the setting corresponds to a time before or after midday.
- ◆ The clock is started after three seconds.

Operating Preparation

Look around the indoor and outdoor units.

Confirm if any obstacles that may prevent the air flow are present near the air conditioner.

1 Remove a protective cover of the outdoor unit.

2 Turn the power switch on.

IMPORTANT To operate the unit, the power switch is fitted to the wall must be set to ON.

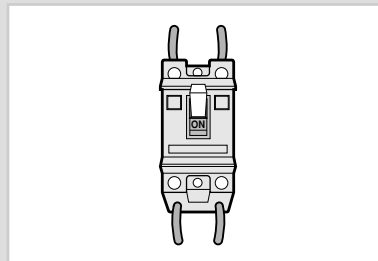

Using the Control Panel on the Indoor Unit

You can operate with indoor unit when you do not wish to or cannot operate the air conditioner with the remote control.

You can : Adapt the auto operating, cooling, fan and timer setting to your specific requirements ;
See pages 10 to 15 for further details.

Exemple : Remote control broken or lost.

Note You must operate the off timer function with indoor unit.

Using the Remote Control

All air conditioner features except timer function can be controlled from your seat, by using the remote control.

You can : Adapt the auto operating, cooling, turbo operating and fan settings to your specific requirements.

Nota You must operate the turbo function with remote control.

Selecting the Automatic Operating Mode

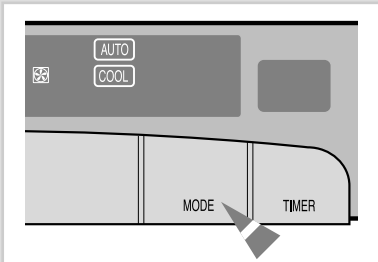
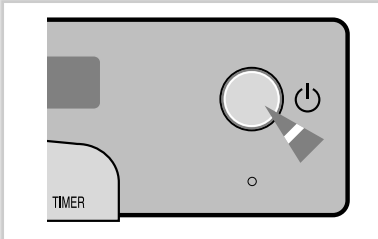

You can start the air conditioner in AUTO mode.

- 1 If necessary, press the ON/OFF (⏻) button.

Result:

- ◆ The power indicator on the control panel comes on.
- ◆ The indoor unit beeps twice.
- ◆ The operation mode previously set is displayed.
- ◆ The air conditioner starts up in the mode selected when the unit was last used.

IMPORTANT The air conditioner is fitted with a protection mechanism to prevent the unit from being damaged when it is started immediately after being:

- ◆ Switched on
- ◆ Stopped

It will start up normally after a three-minute rest period.

- 2 If the AUTO COOL indicator is not displayed, press MODE button one or more times until it appears.

Result:

- ◆ The indoor unit beeps each time you press MODE.
- ◆ The air conditioner starts up in AUTO mode.

To operate the unit by remote control, press the AUTO COOL button.

Note In AUTO mode, the optimum fan speed is selected automatically and cannot be changed.

- ◆ You can change modes at any time.

- 3 To control the air flow direction when necessary, refer to page 14.

Cooling Your Room

You must select the COOL mode if you wish to adjust the:

- ◆ Cooling temperature
- ◆ Fan speed when cooling

1 If necessary, press the ON/OFF (⏻) button.

- Result:**
- ◆ The power indicator on the control panel comes on.
 - ◆ The indoor unit beeps twice.
 - ◆ The operation mode previously set is displayed.
 - ◆ The air conditioner starts up in the mode selected when the unit was last used.

IMPORTANT The air conditioner is fitted with a protection mechanism to prevent the unit from being damaged when it is started immediately after being:

- ◆ Switched on
- ◆ Stopped

It will start up normally after a three-minute rest period.

2 If the COOL indicator is not displayed, press the MODE button one or more times until it appears.

- Result:**
- ◆ The indoor unit beeps each time you press MODE.
 - ◆ The air conditioner starts up in COOL mode.

To operate the unit by remote control, press the COOL button.



Note ◆ You can change modes at any time.

3 If the “SET TEMP” and “TEMP” indicators are not displayed, press the TIME/TEMP. SELECT button to appear it.

4 To adjust the temperature, press the TIME/TEMP. ▲ or ▼ buttons one or more times until the required temperature is displayed. Possible temperature are between 18°C(65°F) and 30°C(86°F) inclusive.

- Result:**
- ◆ Each time you press the TIME/TEMP. ▲ or ▼.
 - The temperature is adjusted by 1°C(1°F)
 - The indoor unit beeps.
 - ◆ The air conditioner will only start cooling if the room temperature is higher than the selected temperature.

5 Select the fan speed by pressing the FAN SPEED button one or more times until the required setting is displayed:

-  Low
-  Medium
-  High

To select the fan speed by remote control, press LOW, MID or HIGH buttons.

Note Each time you press FAN SPEED, the indoor unit beeps.

6 To control the air flow direction when necessary, refer to page 14.

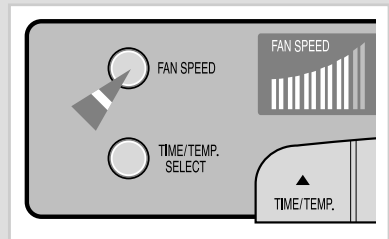
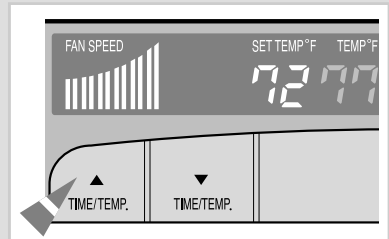
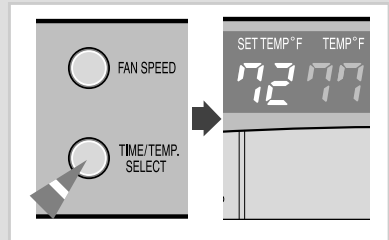
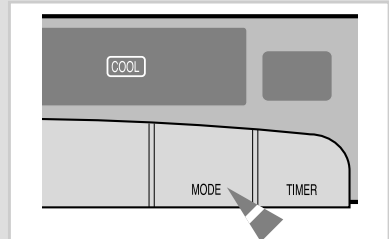
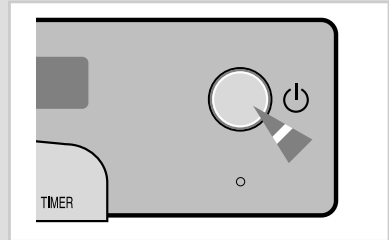

Changing the Room Temperature Quickly

The turbo function is used to cool your room as quickly as possible.

Example: You have just come home and find that the room is very hot. You wish to cool it down as quickly as possible.

The turbo function operates for 30 minutes with the maximum settings before returning automatically to the mode and temperature previously selected.

The turbo function can be controlled by using remote control.

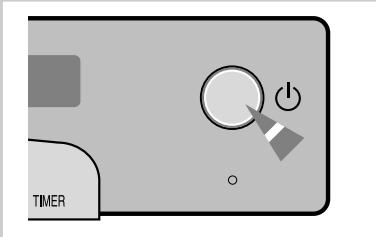

- 1 If necessary, press the ON/OFF() button.

Result:

- ◆ The power indicator on the control panel comes on.
- ◆ The indoor unit beeps twice.
- ◆ The operation mode previously set is displayed.
- ◆ The air conditioner starts up in the mode selected when the unit was last used.

IMPORTANT The air conditioner is fitted with a protection mechanism to prevent the unit from being damaged when it is started immediately after being:

- ◆ Switched on
- ◆ Stopped

It will start up normally after a three-minute rest period.

- 2 Check to see whether the operation mode is positioned at "AUTO COOL" or "COOL" ; the turbo operation cannot be selected when the unit is in the "FAN" operation mode.

- 3 Press the TURBO button on the remote control.

Note

- ◆ The temperature and fan setting are adjusted automatically.
- ◆ The TURBO indicator on the control panel comes on.
- ◆ The air conditioner cools the room as quickly as possible.
- ◆ After 30 minutes, the air conditioner is reset automatically to the previous mode, temperature and fan settings.

Remote control

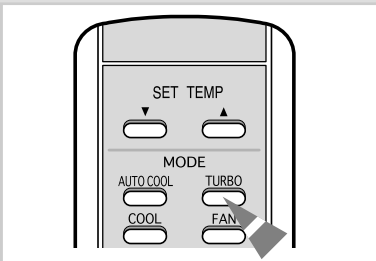

- 4 If you wish to stop the Turbo function before the end of the 30-minute period, press the TURBO button again.

Result:

- ◆ The air conditioner is reset automatically to the previous mode.

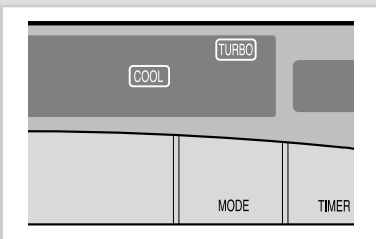

- 5 To control the direction of the air flow, refer to page 14.

Airing Your Room

If the atmosphere in your room is stale, you can air the room using the Fan feature.

- 1 If necessary, press the ON/OFF (⏻) button.

Result:

- ◆ The power indicator on the control panel comes on.
- ◆ The indoor unit beeps twice.
- ◆ The operation mode previously set is displayed.
- ◆ The air conditioner starts up in the mode selected when the unit was last used.

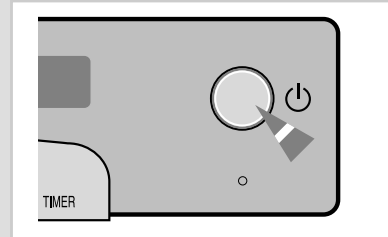

- 2 If the FAN indicator is not displayed, press the MODE button one or more times until it appears.

Result:

- ◆ The indoor unit beep each time you press MODE.
- ◆ The FAN indicator on the control panel comes on.
- ◆ The air conditioner starts up in Fan mode.
- ◆ The temperature is set automatically.

To operate the unit by remote control, press the FAN button.

Note You can change modes at any time.

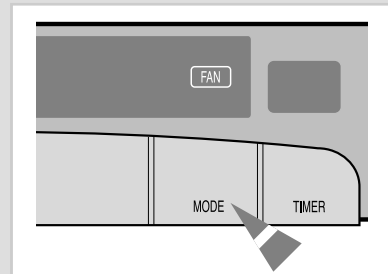

- 3 Select the fan speed by pressing the FAN SPEED button one or more times until the required setting is displayed:

||| Low
||| Medium
||| High

To select the fan speed by remote control, press LOW, MID or HIGH buttons.

Note Each time you change the fan setting, the indoor unit beeps.

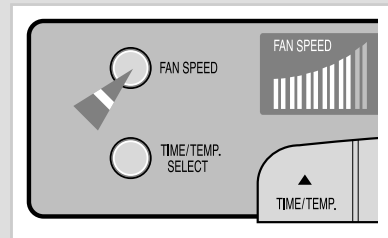

- 4 To control the direction of the air flow, refer to page 14.

Adjusting the Air Flow Direction Horizontally

Remote control

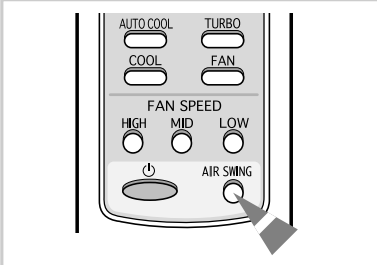

Depending on the position of the indoor unit, you can adjust the position of the air flow blades on the top of the unit, thus increasing the efficiency of the air conditioner. You can control by using remote control.

- 1 Press the AIR SWING button on the remote control.
Result: The blades are moved between right and left.

- 2 To stop the blades, press the AIR SWING button again.

To set to the required position, press the AIR SWING button again when the blades are in the required position.

Adjusting the Air Flow Direction Vertically



Just as the air flow blades can be adjusted vertically, they can also be adjusted by the hands.

Set the horizontal blades in the desired direction.

- Note**
- ◆ Effective control of air flow direction.
 - Adjust the blades to face upward for cooling.

Setting the Off Timer

The Off Timer enables you to set the air conditioner to switch off automatically after a given period of time, by pressing one single button. The unit can be switched off automatically after one hour, two hours, three hours, four hours or five hours. You can control by using indoor unit.

1 If necessary, press the ON/OFF(⏻) button and select the operating mode.

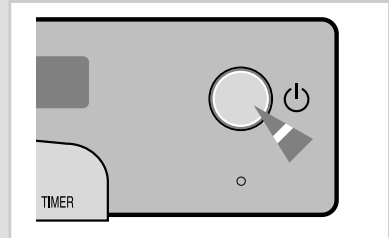

2 Press the TIMER button.

Note Each time the button is pressed, the following are displayed sequentially:

1:00 → 2:00 → 3:00 → 4:00 → 5:00 → AM 10:30

Result:

- ◆ The TIMER indicator is displayed.
- ◆ When the timer operation function starts, the remaining time is displayed.

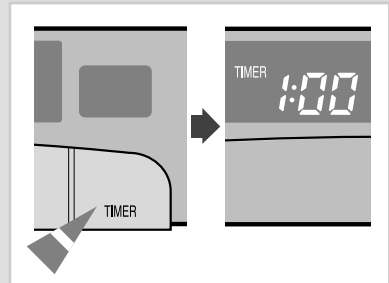

Cancelling the Off Timer

If you no longer wish to use the off timer function, you can cancel it at any time.

Press the TIMER button one or more times until the room temperature or the current time is displayed.

Result:

- ◆ The off timer is cancelled.
- ◆ The air conditioner operates normally.

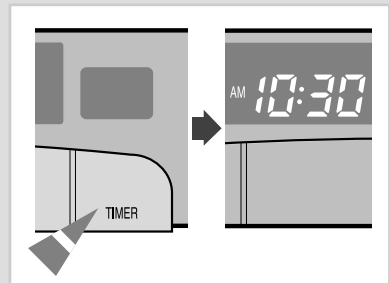

Operating Recommendation

Here is a recommendation that you should follow when using your air conditioner.

TOPIC	RECOMMENDATION
Power failure	If a power failure occurs when the air conditioner is operating, the unit is switched off. When the power returns, the air conditioner start up again automatically.

Temperature and Humidity Range

The following table indicates the temperature and humidity ranges, within which the air conditioner can be used.

Mode	Outdoor Temperature	Indoor Temperature	Indoor Humidity
Cooling	21°C to 43°C approx. (70°F to 109°F approx.)	18°C to 32°C approx. (65°F to 90°F approx.)	80% or less If the unit is used for long periods at a high humidity level, water may condense on and drip from the surface of the unit.

* If the cooling operation is used at over 33°C/92°F(indoor temperature) then, does not a full capacity.

Cleaning Your Air Conditioner

To get the best possible use out of your air conditioner, you must clean it regularly to remove the dust that accumulates on the air filter.

IMPORTANT Before cleaning your air conditioner, ensure that you have switched off the breaker used for the unit.

- 1 Loosen two fixing screws of left and right.
Pull the air inlet grille lightly and pull out the air filter in an upward direction to release them.
- 2 Remove all dust on air filter with a vacuum cleaner or brush.
In case of serious dust accumulation, put the air filter in warm detergent water and shake it vertically.
- 3 Dry the air filter.
- 4 When you have finished, insert the bottom part of the filter into their slot and push down until they click into place.
- 5 Clean the front panel with the damp cloth and mild detergent (do not use benzene, solvents or other chemicals).

Note If you have not used the air conditioner for a long period of time:

- ◆ Check that the air filter is clean and remove any dust
- ◆ Set the fan going for three to four hours to dry the inside of the air conditioner thoroughly
- ◆ Turn the switch off after stopping the operation
- ◆ Cover the outdoor unit with a protective cover.

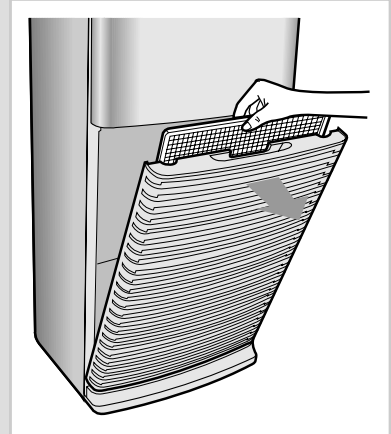

Solving Common Problems

Before contacting the after-sales service, perform the following simple checks. They may save you the time and expense of an unnecessary call.

Problem	Explanation / Solution
The air conditioner does not operate at all	<ul style="list-style-type: none">◆ Check that the power switch is turned ON.◆ Check that the power light on the control panel is on; if necessary, press ON/OFF (⏻).◆ Check whether the timer operation function stops.
The air conditioner does not operate with the remote control	<ul style="list-style-type: none">◆ Check that there are no obstacles between you and the indoor unit.◆ Check the remote control batteries.◆ Check that you are close enough to the indoor unit (7 meters / 23ft or less).
The air conditioner does not cool	<ul style="list-style-type: none">◆ Check that the correct operating mode has been selected AUTO or COOL.◆ The room temperature may be too low.◆ Dust may be blocking the air filter guard; refer to page 17 for cleaning instructions.◆ Check that there is no obstacle in front of the outdoor unit.
The fan speed does not change when you press the FAN SPEED button	<ul style="list-style-type: none">◆ Check that the operating mode is set to COOL or FAN; in the AUTO mode, the fan speed changes automatically
The air flow direction does not change when you press AIR SWING	<ul style="list-style-type: none">◆ Check that the air conditioner has been switched on.
The off timer is not correctly triggered	<ul style="list-style-type: none">◆ Check that the off timer has been programmed correctly; see page 15.
Smells are permeated in the room during air conditioning	<ul style="list-style-type: none">◆ Air the room.

Technical Specification

ITEM		MODEL		Indoor unit		Outdoor unit	
				AP500PF		AX500PF	
Performance Ratings	Cooling Capacity	BTU/h		49600			
	Moisture Removal	Pts/h		11.83			
	Indoor Air Flow (High)	CFM		1164.5			
	Sound rating	dBA		56		62	
Electrical Data	Power Source	ø/V/Hz		3/208-230/60			
	Power Consumption	W		5100			
	Operating Current	A		16			
	Max. TD Fuse/Breaker	A		30			
Dimension & Weight	Dimension	W x H x D	in	27 $\frac{45}{64}$ x 75 $\frac{25}{32}$ x 23 $\frac{39}{64}$		47 $\frac{15}{64}$ x 53 $\frac{59}{64}$ x 21 $\frac{17}{64}$	
	Shipping Weight		lbs	182		251 $\frac{3}{10}$	
Refrigeration Lines	Liquid Line O.D		in	3/8			
	Suction Line O.D		in	3/4			
	Connections			Flare			
	Factory Pre-charge		ft	49 $\frac{1}{5}$			
	Max. Line Length		ft	82			
	Max. Height Difference		ft	49			

* Standard rating conditions Cooling

	Indoor		Outdoor	
	DB	WB	DB	WB
°C	26.7	19.4	35.0	23.9
°F	80	67	95	75

METHOD OF INSTALLATION

- ▶ Be sure to read the installation manual carefully to ensure sufficient realization of the excellent performance of the unit.
- ▶ Be sure to drill a hole in the wall necessary for installation before attempting to install the unit.
- ▶ After completion of installation, be sure to perform a test operation of the unit to check for any problem, and then deliver the unit to the customer if the test results are acceptable.
- ▶ After completion of test operation, hand over the owner's manual, installation manual, and warranty card to the customer.
- * As the installation work requires special skill, be sure to request a qualified dealer to take care of the installation of your unit; the user should not attempt to install his/her unit by himself/herself.
- * **Do not attach any electric heating device or electric heater to the unit.**
Do not attempt to disassemble or modify the unit by yourself.
(It may cause machine trouble, electric shock or fire.)

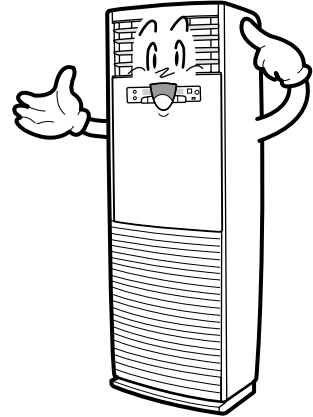

Absolute Checkpoints

1. Drilling a hole in the wall

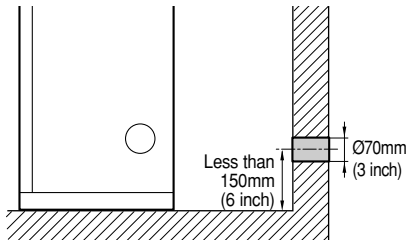

2. Drain check

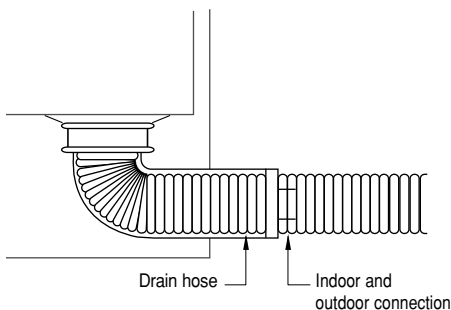

▶ Refer to page 27 for detailed procedures. ◀

TABLE OF CONTENTS

ACCESSORY PARTS LIST

- Connection Parts 21
- Others 21

SELECTION OF INSTALLATION PLACE

- Indoor Unit 22
- Outdoor Unit 22

ELECTRICAL WORK 23

INSTALLATION METHOD

- Installation Procedures 25
- Connection of Refrigerant Piping 26
- Drilling a Hole in the Wall 27
- Drain Hose 27
- Rat-prevention Cover 27
- Indoor Unit 28
- Outdoor Unit 28







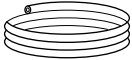

AIR PURGE 29

REFRIGERANT CHARGING 30

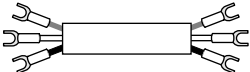





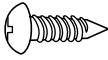

CHECK AND TEST OPERATION 31

ACCESSORY PARTS LIST

Connection Parts

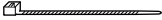
No.	Part Name	Q.ty	Remarks
1	Insulation for piping 	1	Option (Piping box)
2	Connecting pipe  $\phi 9.52\text{mm}$ (3/8 inch)	1	
3	Connecting pipe  $\phi 19.05\text{mm}$ (3/4 inch)	1	
4	Connection wiring (3 strand) 	1	
5	Drain hose 	1	Piping box
6	Finishing tape 	2	
7	Insulation tape 	1	
8	Insulation tube for indoor unit piping connection 	1	
9	Ring terminal 	8	

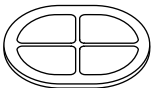
Others

No.	Part Name	Q.ty	Remarks	
1	Leg holder for indoor unit 	4	Piping box	
2	Screw 	TH M4X12		4
		TH M4X25		4
3	Indoor unit fixing holder 	1		
4	Leg holder for outdoor unit 	4		
5	Insulation rubber bottom 	4		
6	Cable tie 	5		
7	Putty 	3		
8	Pipe band 	3		
9	Rubber cabi slot 	1		
10	Rubber cabi hole 	1		

SELECTION OF INSTALLATION PLACE

Indoor Unit

- ◆ Install the unit at a place close to the wall facing the outside as it is necessary to perform piping connection with the outdoor unit.
 - It is effective to install the unit at a window side to ensure uniform distribution of indoor temperature.
- ◆ Install the unit at a place where there is no obstacle against the wind around the air inlet and air outlet.
- ◆ Install the unit horizontally at a stable, rigid place. (When installing the unit at a place subjected to vibration, noise may occur.)
- ◆ Avoid a place near the door which is frequented by people.
- ◆ Avoid a place subject to direct sunlight.

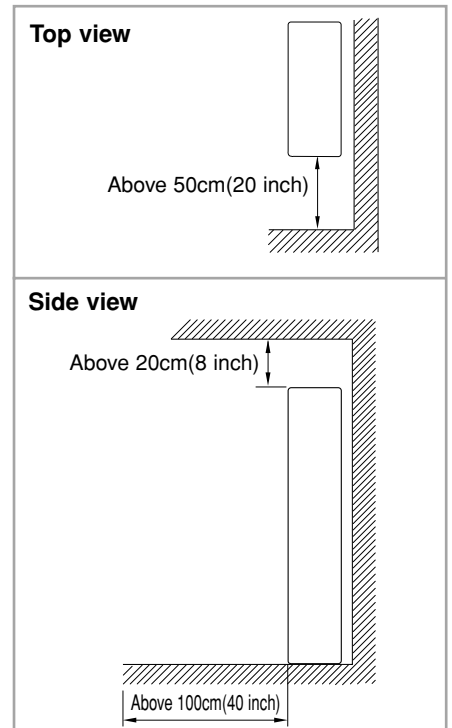

Outdoor Unit

- ◆ Place free from the risk of combustible gas leakage.
- ◆ Place which can bear the weight of the unit.
- ◆ Place which can bear the fixing strength of the outdoor unit.
- ◆ Avoid a place subject to oil (including machine oil).
- ◆ Avoid a saline place.
- ◆ Avoid a place subject to sulfide gas (hot spring zone). (When installing the unit at such special environmental conditions, it may cause machine trouble. When it is unavoidable to use such places. It requires special maintenance.)
- ◆ A place where the discharge air and noise of the outdoor unit do not disturb the neighborhood. (Take special care not to cause any inconvenience to your neighbors when installing the unit on the borderline with your neighborhood.)
- ◆ A place where strong wind does not head against the air outlet of the outdoor unit. (If a strong wind heads directly against the air outlet at the time of cool operation, a safety device can be operated.)
- ◆ Do not install the outdoor unit at an unstable place such as outer wall of an apartment or building. The outdoor unit may fall down, causing severe personal or property damage or loss.

※ If there is any unavoidable reason to install the unit at such a place, take the following measures against the wind;

1. When installing the unit at a roadside concentrated with buildings, install it parallel with the road.
2. Install the unit so that the air outlet faces toward the wall at a place such as rooftop, which may be subjected to strong wind.

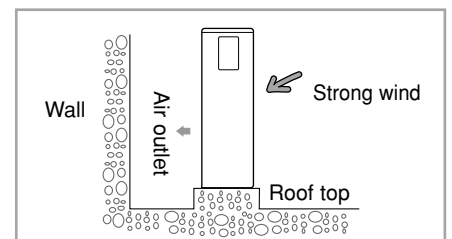

- ◆ The outdoor unit should be installed in accordance with the service space.

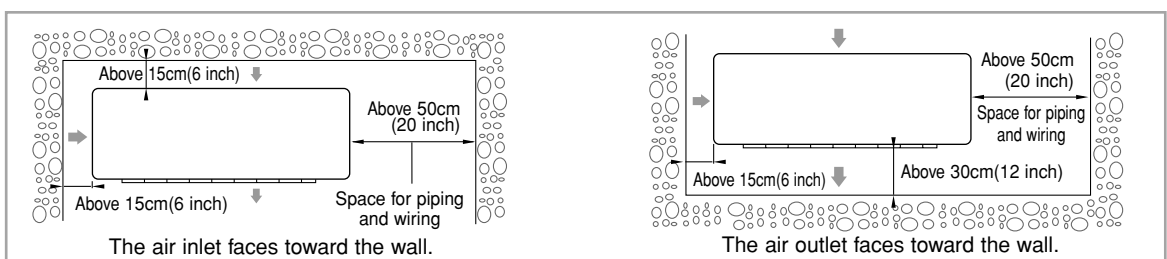

ELECTRICAL WORK

The electrical work should be performed by a specialist qualified for the work.

- ◆ Use the three phase power supply, and be sure to install the sub power distributing board for exclusive use with the unit(separately purchased by the user).
- ※ Avoid octopus-type wiring as it can cause a drop in voltage, thus resulting in poor performance of the automatic control circuit.
- ◆ Be sure to install circuit breaker (separately purchased by the user).
- ◆ Be sure to connect the grounding wire.

□ Electric power spec

Power	3phase 3wires 208 ~ 230V / 60Hz	
Ampere of breaker	50 A	
Knife switch	Switch	30 A
	Fuse	30 A
Size of grounding wire	AWG 14	
Min. size of electric wires from/to the indoor/outdoor unit	AWG 19	
Size of electric input wires	AWG 9	

CAUTION

- ◆ Be sure to use the wires, and switches or fuses of power distribution board are qualified and fulfill the specification.
- ◆ Be sure to install knife switch or circuit breaker on the power distribution board.
- ◆ The electrical and grounding work should be performed as per “ technical specification of electrical facilities ” and “ specification of internal wiring ”.
- ◆ Be sure to connect main electrical input wires with bolted connectors using compressed terminal.

ELECTRICAL WORK

When connecting 3Phase 3wires 208 ~ 230V AC

1. Remove cover of electric box on side panel of outdoor unit.
2. Connect electric input wires (R,S,T) to each terminal (R,S,T) of the electric box on outdoor unit respectively.
(Input wires are purchased by the user separately.)
3. Connect electric wires (red, white, black) to each terminal (red, white, black) on indoor and outdoor unit respectively.

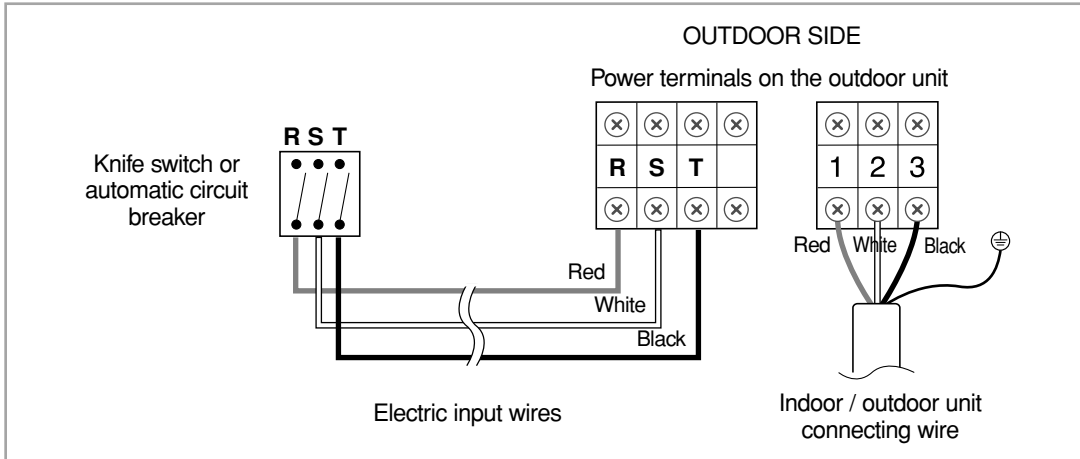

INSTALLATION METHOD

Installation Procedures

1. Open the inlet grille, and remove the flare nut.
2. Bend the connection pipe to an appropriate length using the spring bender depending upon the installation place.
 - Allowable pipe length : Maximum 25m(82ft)
 - Allowable pipe drop distance : Maximum 15m(49ft)
 - Make no more than ten bending points on the pipe
- * When the pipe length is in excess of the standard pipe length of 5m(16ft 5 in), add the refrigerant (R-22) of 50g(0.11lb) for each additional 1m(3.28ft).

CAUTION

- ◆ If the pipe is lengthened, the performance of the unit is degraded, and the service life is shortened. Therefore, the pipe length should be as short as possible (less than 15m/49ft).

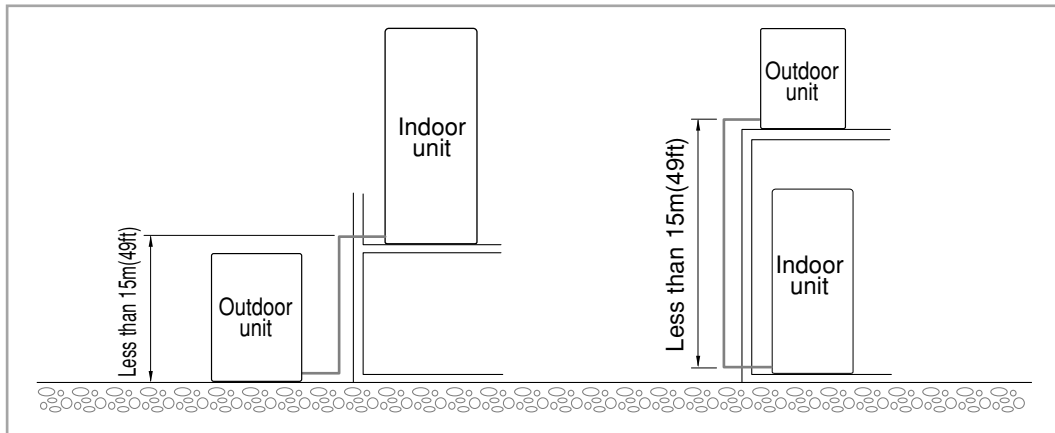

3. Install the high pressure pipe to the heat exchanger liquid pipe, and the low pressure pipe to the heat exchanger gas pipe respectively using the flare nut, taking care not to cause any leakage of refrigerant.
4. Be sure to insulate the pipe with appropriate insulation material.
5. Insert the drain hose into the drain pipe, and connect them by tying them to the cable tie to prevent any water leakage.
6. After completion of the installation, check the connecting area for any gas leakage.
7. Wind a finish tape when the wiring of the refrigerant pipe, the unit, and the drain piping are completed.

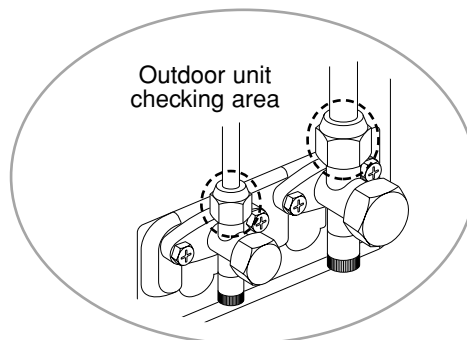
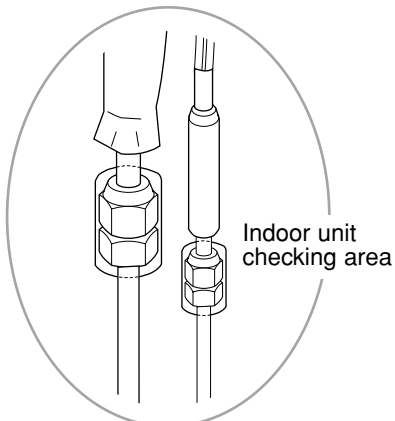

INSTALLATION METHOD

Connection of Refrigerant Piping

Flare Processing

1. Cut the pipe using the pipe cutter.

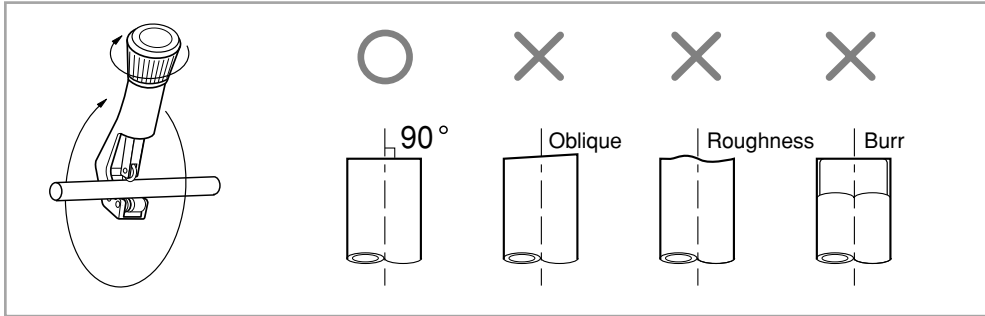

2. Insert the flare nut into the pipe, and then perform the flare processing.

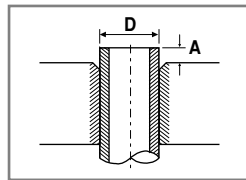
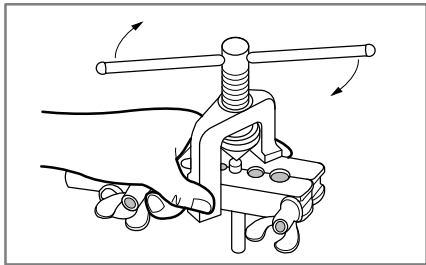

Outer Diameter	A
ø 9.52 mm(3/8")	1.8 mm(7/100")
ø 19.05 mm(3/4")	2 1/5 mm(9/100")

◆ Unproper flaring

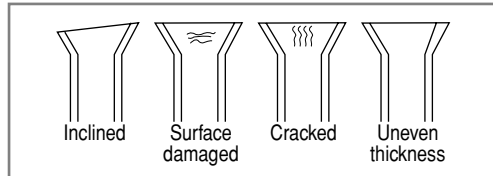

Pipe Bending

1. Perform bending of the pipe using the bender which has a specified bending radius.
2. Be sure to take full care to perform bending of the pipe successfully at one time. Bending and unbending the pipe more than twice makes the bending work increasingly difficult.
3. You may use the spring inserted into the gas pipe instead of the bender to bend the pipe.
4. When you bend the pipe using the spring, hold the pipe with both hands to prevent any distortion, and secure a minimum bending radius of more than 100mm(4 inch).

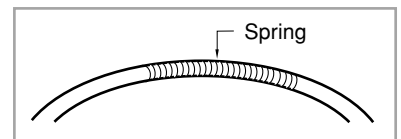

Tightening of Connection Parts

- ◆ Align the center of the connection piping, and tighten the flare nut by turning it with hand. Then tighten it again using the spanner in the direction as shown in the figure.

Outer Diameter	Tightening Torque	Final Torque	Remarks
ø 9.52mm(3/8")	400 kg • cm(28 4/5 ft•lb)	450 kg • cm(32 1/5 ft•lb)	
ø 19.05mm(3/4")	700 kg • cm(50 3/5 ft•lb)	750 kg • cm(54 1/5 ft•lb)	

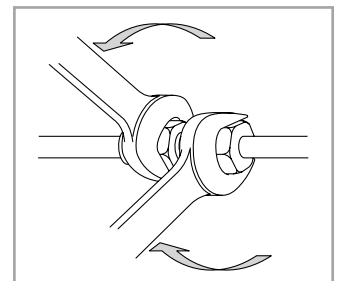

Drilling a Hole in the Wall

- ◆ Drill a hole of 70mm(3 inch) in diameter to the outside.
- ◆ The drilling should be done at a distance of less than 150mm(6 inch) from the floor facing the indoor unit.

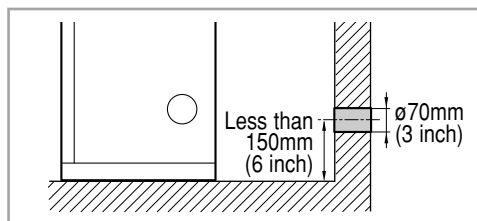

Drain Hose

- ◆ Extend the drain hose to the drain pan, and fix it with the tape or a cable tie to prevent separation. Then make a covering of it so that water can not flow outwardly.

Piping Material	Vinyl Chloride(Outer diameter ϕ 16mm/0.63 inch)
Insulator	Foamed Polyethylene

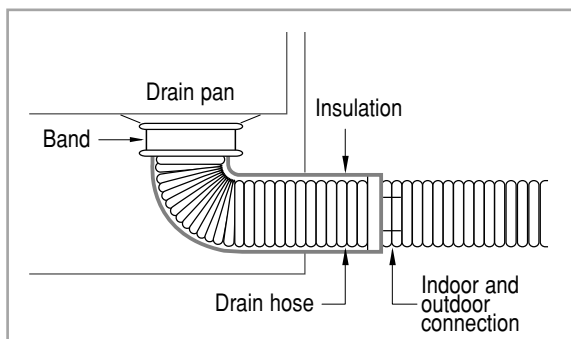

CAUTION

1. As the draining is of natural drain type, make the drain hose direct downward.
2. If there is any foreign substance in the drain plate, it may clog the drain pipe. Therefore, be sure to remove the foreign substance inside after installation.
3. After completion of installation, be sure to pour water into the drain pan, and then check the draining condition.
(There is no problem in draining when the draining is completed within 20 seconds.)

Rat-prevention Cover

- ◆ The piping of this unit can be connected to the left and rear side.
- ◆ When you hit the area for piping connection slightly with a hammer, a hole is made.
- If there is any reason to change connection, fill in hole with rubber cabi slot.

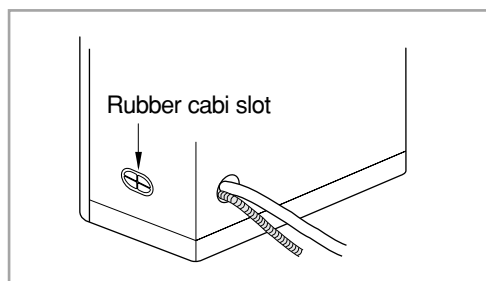
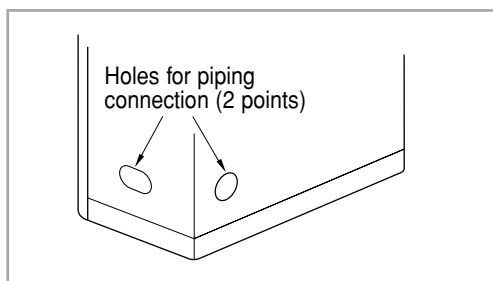

INSTALLATION METHOD

Indoor Unit

In order to install drain hose through wall, adjust height (max. 150mm/5.91 inch) of the indoor unit using leg holder.

□ Fixing to the floor

◆ When using the leg holder of the indoor unit.

1. Lie down the unit on flat floor.
2. Insert the leg holders into screwed holes and then fasten them clockwise.
3. Turn the unit right and adjust horizontal line of it.
✳ Mis-alignment of the unit can cause vibration and noise.

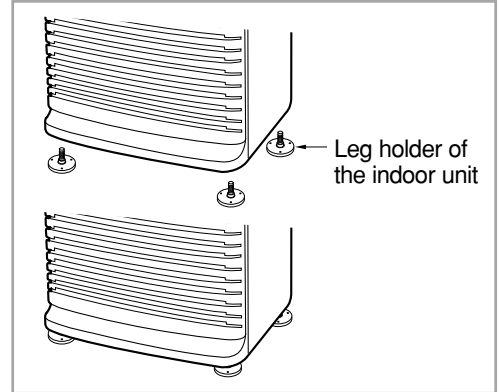

□ Fixing to the wall

◆ When using fixing holder of the indoor unit.

1. Fix the holder using long screw bolts on wall.
2. Fix the unit using two screw bolts or four anchor bolts.
(Size of the screw hole on the holder is $\phi 4.5\text{mm}/0.18\text{ inch}$ and size of the bolt is $\phi 6\text{mm}/0.24\text{ inch}$).

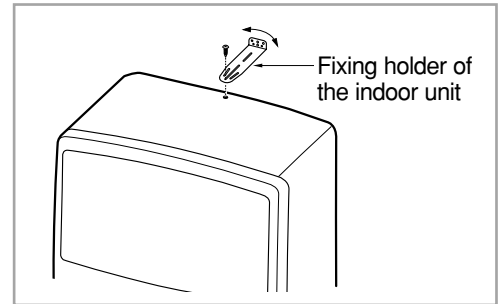

Outdoor Unit

□ When using the anchor bolt

1. Fix the unit on a flat, rigid floor using the anchor bolt.
(Anchor bolt : M10 x 4 points - separately purchased)

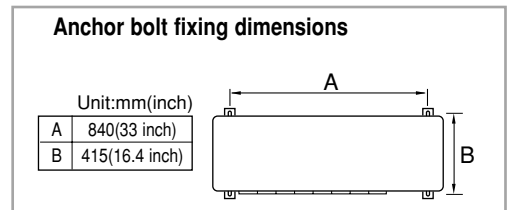

□ When using the leg holder of the outdoor unit

1. Insert the foot holder (4EA).
2. Remove the nut fastened to the leg holder, and then insert the leg holder into the hole of the outdoor unit leg.
3. Fix the unit securely with the nut.

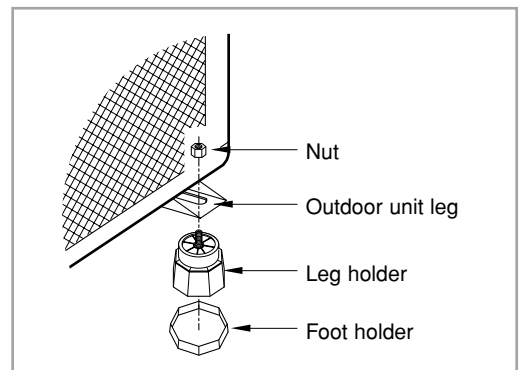

AIR PURGE

◆ Be sure to perform the air purge of the indoor unit, and piping using the refrigerant of the outdoor unit at the time of installation.

1. Connect the charging hose of low pressure side of manifold gauge to the packed valve having a service port (3/4" Packed valve) as shown at the figure.
2. Open the valve of the low pressure side of manifold gauge counter-clockwise.
3. Purge the air from the system using vacuum pump for about 10 minutes.
 - Close the valve of the low pressure side of manifold gauge clockwise.
 - Remove the hose of the low pressure side of manifold gauge.
4. Set valve cork of both liquid side and gas side of packed valve to the open position.
5. Mount the valve stem nuts to the 3-way valve. And mount the service port cap to 3-way valve.
6. Check for gas leakage.
 - At this time, especially check for gas leakage from the 3-way valve's stem nuts, and from the service port cap.

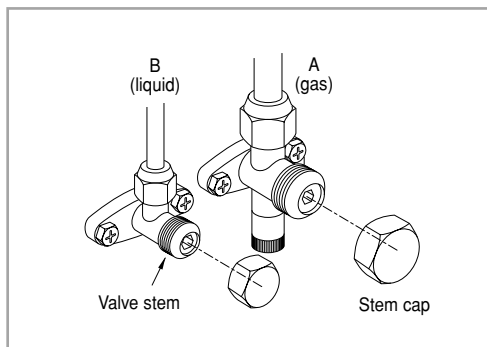
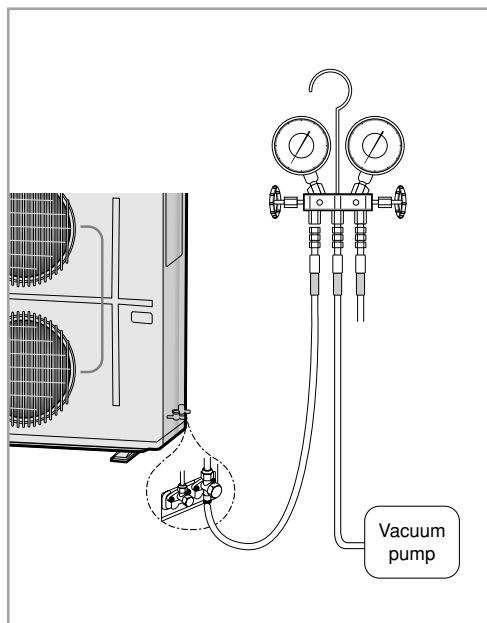
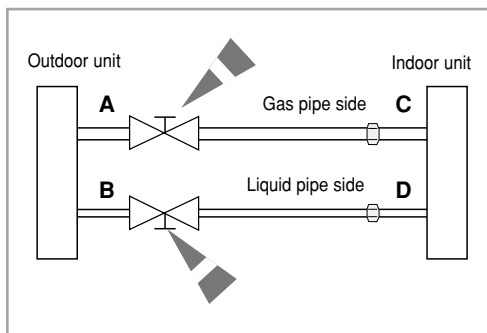

REFRIGERANT CHARGING

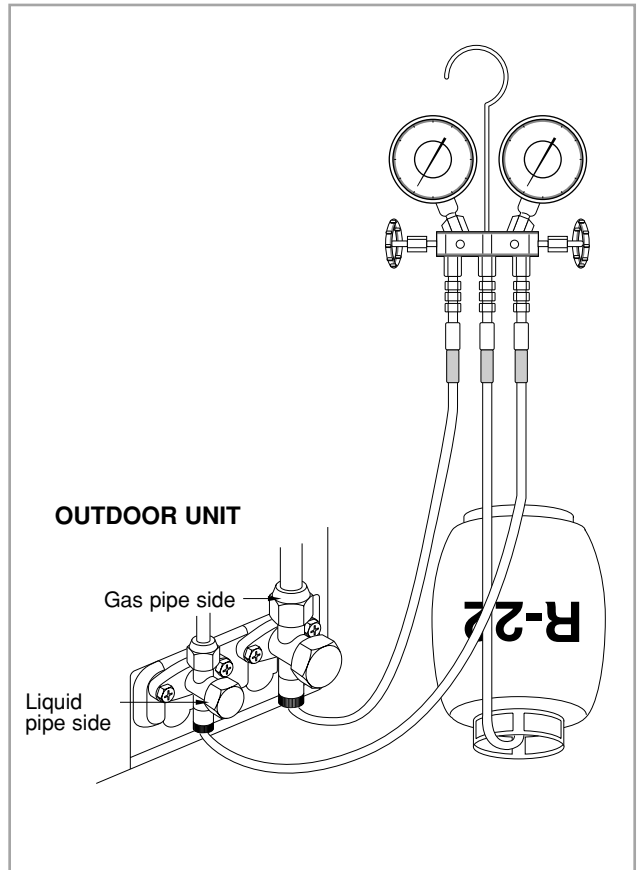
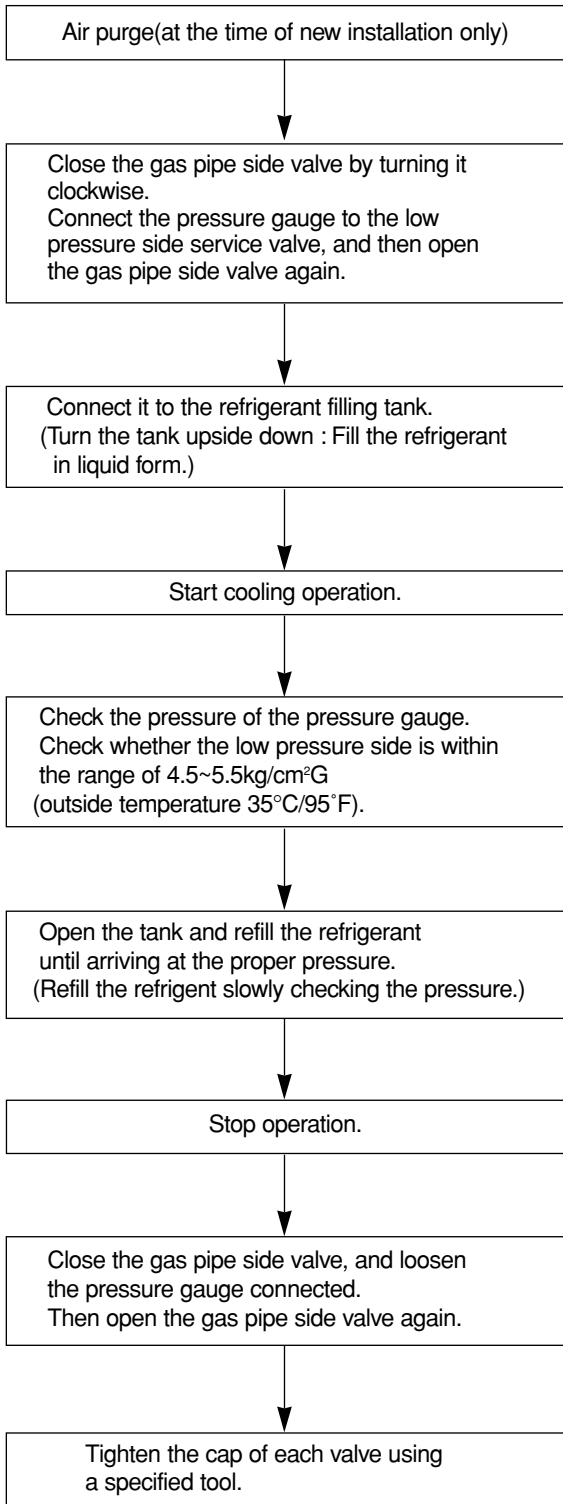

CHECK AND TEST OPERATION

Check

- ◆ Be sure to check the following again after completion of installation.

1. Check the piping connection area for any gas leakage.

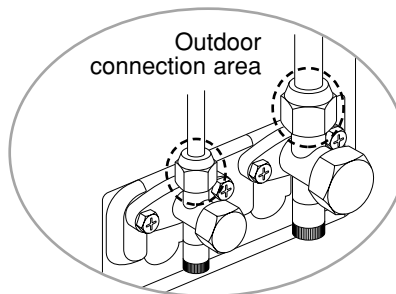
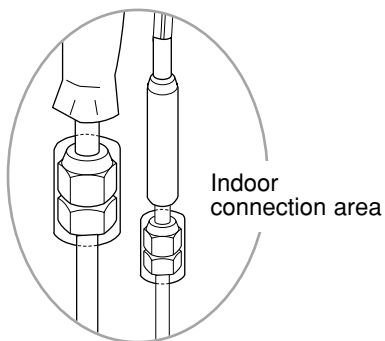

2. Is the drain hose properly connected?

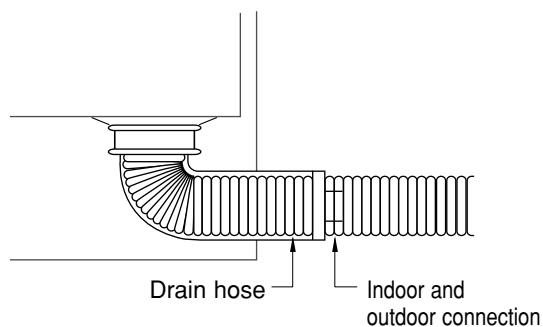

3. Is the insulation of the piping in good condition?

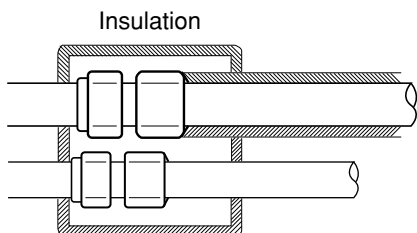

4. Is grounding properly made?

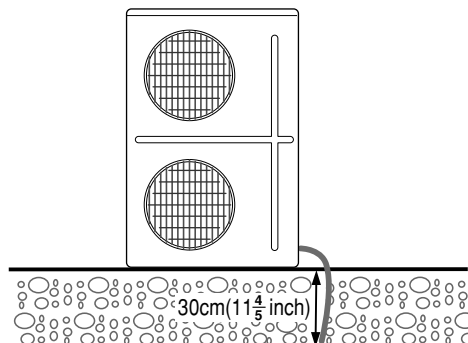

CHECK AND TEST OPERATION

Test Operation

- ◆ After checking, read the owner's instructions carefully, and perform a test operation. Then deliver the unit to the customer.

(When delivering the unit, be sure to read carefully and follow the contents of the owner's instructions.)

CAUTION

1. Be sure to check whether the service valve is opened before attempting to perform the test operation.
2. Never attempt to start test operation by force pressing the electronic contactor as it is very dangerous.
(This is very dangerous as the protective device does not work.)
3. Be sure to perform the test operation after installation.
It is easy to start the test operation in winter if you increase the sensor temperature to 23°C(73.4°F) ~ 25°C(77°F) by holding the indoor temperature sensor. (Cooling operation)

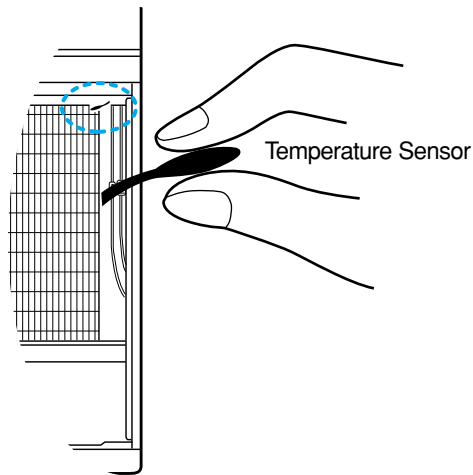

MEMO

THIS AIR CONDITIONER IS MANUFACTURED BY:

